

SL60 | 60cm Slimline Cooker Hood



Features:

- 350m³/h extraction rate
- Noise level: 55dBa
- Front push button controls
- 4 Layer aluminium grease filters
- Grease filters are dishwasher safe
- Voltage & Frequency: 220-240/50
- Lighting: 2 x 20W lights
- Unbranded with the EUROair logo for seamless coordination with your kitchen appliances.

Included:

- Charcoal Filters for recirculation
- 1x Flex Pipe: 1m x 125mm diameter
- Butterfly

Extraction Rate:

These Cooker Hoods go beyond the norm, boasting an impressive 350m³/h airflow. It is also worth noting that the noise level of 55dBa is equivalent to the sound of a household fridge. Enjoy optimal ventilation without disruptions, setting it apart from conventional cooker hoods rated at 60-70dBa.



SL60BL Price:
RRP. R1850,00

SL60IN Price:
RRP. R2075,00

Product Codes:

- **SL60BL:**
Black Slimline Cooker Hood
- **SL60IN:**
S/steel Slimline Cooker Hood

Conscious Choice:

The size and capacity of the extraction should match the specific requirements of your kitchen. The hoods extraction is measured in cubic meters for the air renovation. The optimal recommendation is to achieve 12 renewals per hour, aligned with your kitchen's volume:

Kitchen volume = width x depth x height
Example: 3 m x 3 m x 2,5 m = 22,5 m³

12 Renovations per hour
Example: 12 x 22,5 m³ = 270 m³

Technical Drawing:

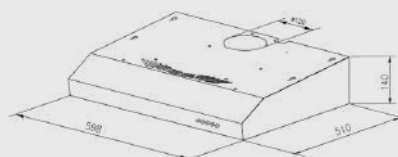

Available Colours:



Appliance Position:

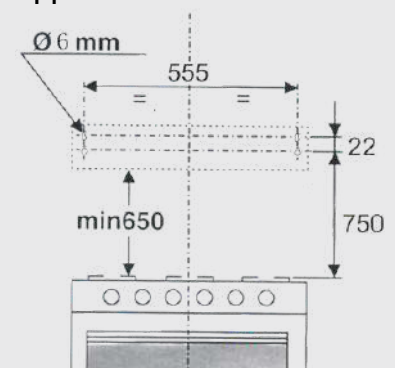

Push Button Controls

1. Press this button to turn the appliance on/off.
2. Press this button to operate in low speed.
3. Press this button to operate in middle speed.
4. Press this button to operate in high speed.
5. Press this button to turn the lamps on.

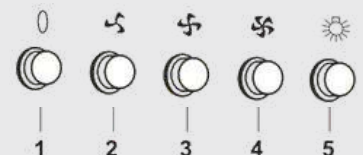

SL90IN | 90cm Slimline Cooker Hood



Features:

- 400m³/h extraction rate
- Noise level: 55dBa
- Front push button controls
- 4 Layer aluminium grease filters
- Grease filters are dishwasher safe
- Voltage & Frequency: 220-240/50
- Lighting: 2 x 20W lights
- Unbranded with the EUROair logo for seamless coordination with your kitchen appliances.

Included:

- Charcoal Filters for recirculation
- 1x Flex Pipe: 1m x 125mm diameter
- Butterfly

Extraction Rate:

These Cooker Hoods go beyond the norm, boasting an impressive 400m³/h airflow. It is also worth noting that the noise level of 55dBa is equivalent to the sound of a household fridge. Enjoy optimal ventilation without disruptions, setting it apart from conventional cooker hoods rated at 60-70dBa.



Price:
RRP. R2595,00

Product Codes:

- **SL90IN:**
S/steel Slimline Cooker Hood

Conscious Choice:

The size and capacity of the extraction should match the specific requirements of your kitchen. The hoods extraction is measured in cubic meters for the air renovation. The optimal recommendation is to achieve 12 renewals per hour, aligned with your kitchen's volume:

Kitchen volume = width x depth x height
Example: 3 m x 3 m x 2,5 m = 22,5 m³

12 Renovations per hour
Example: 12 x 22,5 m³ = 270 m³

Technical Drawing:

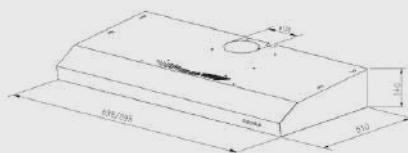

Available in Stainless Steel:



Appliance Position:

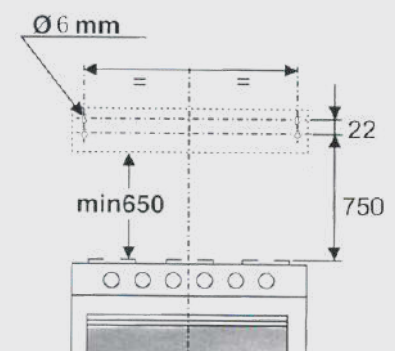

Push Button Controls

1. Press this button to turn the appliance on/off.
2. Press this button to operate in low speed.
3. Press this button to operate in middle speed.
4. Press this button to operate in high speed.
5. Press this button to turn the lamps on.

