

# E915 | 90cm Freestanding Gas / Electric Stove



## Features:

- 8 function electric oven
- Multifunction oven
- Twin thermo-ventilated oven
- 121Lt oven capacity
- Dimensions: 90 x 60 cm
- 5 high efficiency gas burners
- 4kW central wok burner
- Flame failure devices (FFD)
- Cast iron pot rests
- One handed ignition
- Digital programmer & timer
- Cooling fan
- Thermo-reflective glass
- Removable triple glass door
- Cool touch external glass
- Push-click storage compartment

## Dimensions:

90cm x 60cm x 90cm



**Price:**  
RRP. R24 995,00

## Product Codes:

- **E 915 BL:**  
Black Freestanding Stove
- **E 915 CR:**  
Cream Freestanding Stove
- **E 915 R:**  
Red Freestanding Stove
- **E 915 X:**  
S/steel Freestanding Stove

## Technical Drawing:

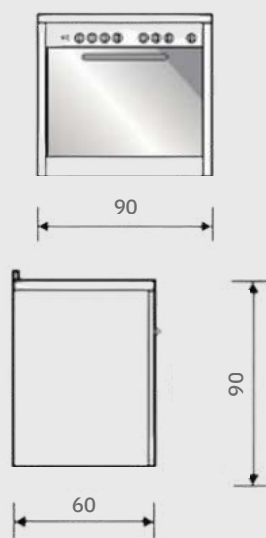

## Available Colours:



# E915 D1 | 90cm Freestanding Gas / Electric Stove



## Features:

- 5 High efficiency gas burners
- 4KW Left hand side wok burner
- Cast iron pot rests
- One handed ignition
- Flame failure devices (FFD)
- 8 function electric oven
- 121Lt oven capacity
- Twin thermo-ventilated oven
- Touch Screen Digital Programmer
- Touch Screen timer
- Cooling fan
- Features chrome accents on the knobs and handle
- Removable triple glass door
- Thermo-reflective glass
- Cool touch external glass
- Push-click storage compartment
- Integrated Ignition + Safety



**Price:**  
RRP. R25 995,00

## Dimensions:

90cm x 60cm x 90cm

## Product Codes:

- **E 915 D1 N:**  
S/steel Freestanding Stove
- **E 915 D1 BL:**  
Black Freestanding Stove

## Technical Drawing:

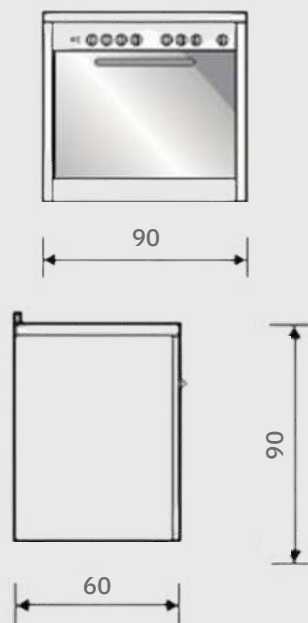

## Available Colours:



# EV 890 SP 2N | 90cm Freestanding Gas / Electric Stove



## Features:

- 8 function electric oven
- Multifunction oven
- Single thermo-ventilated oven
- 115Lt oven capacity
- Dimensions: 90 x 60 cm
- 5 high efficiency gas burners
- 4kW central wok burner
- Flame failure devices (FFD)
- Cast iron pot rests
- One handed ignition
- Mechanical ringing timer
- Cooling fan
- Thermo-reflective glass
- Removable triple glass door
- Cool touch external glass
- Push-click storage compartment



**Price:**  
RRP. R21 995,00

## Dimensions:

90cm x 60cm x 90cm

## Product Codes:

- **EV 890 SP 2N:**  
S/Steel Freestanding Stove

## Technical Drawing:

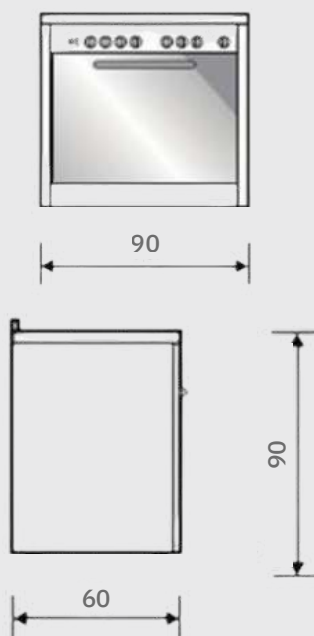

## Available in Stainless Steel:

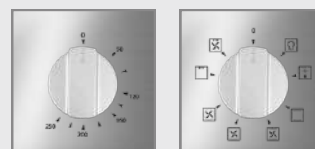

# E530 AV X | 60cm Freestanding Gas / Electric Stove



## Features:

- 4 Gas burners
- 4 Function oven
- Enamelled pot rests
- Auto ignition
- Flame failure devices (FFD)
- Electric static oven and grill
- Thermostatically controlled oven
- 51Lt oven capacity
- Temperature range: 50 - 260°C
- Crystal glass lid (Splash-back)
- Double glass door
- Mirror glass finish
- Material: Stainless steel
- Dimensions: 56,5 x 60cm

## Technical Drawing:

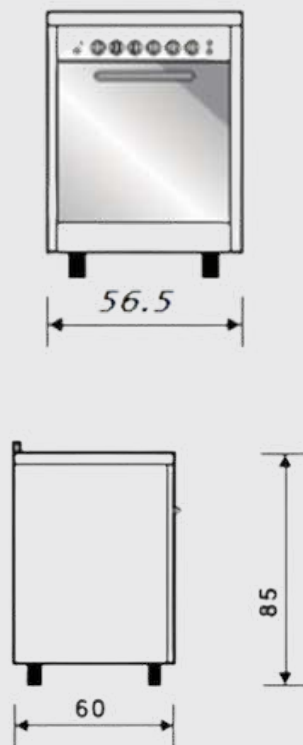

## Available in Stainless Steel:



## Product Codes:

- E530 AVX:  
S/steel Freestanding Stove



Price:  
RRP. R9 999,00

